

SimPal-G212

GSM Alarm System

Plug & Play home alarm system
Elderly care alarm system

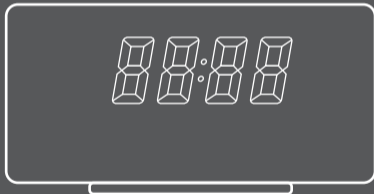

APP Management and Settings
SimPal GSM



CONTENTS

Chapter 1: General system overview	02		
1.1 Product description	02		
1.2 Package contents	03		
1.3 Alarm panel instruction	04		
1.4 Remote control instruction	05		
Chapter 2: Start to use	06		
2.1 Installation	06		
2.2 LED indicator and beeper	07		
2.3 Zone type and alarm tone	08		
2.4 Pair remote control and wireless sensor	09		
2.4.1 Pair remote control	09		
2.4.2 Pair wireless sensor	09		
2.4.3 Delete remote control and wireless sensor	09		
Chapter 3: SMS alarm and Settings	10		
3.1 Register Master and User number	10		
3.2 Register Master number	10		
3.3 Register User number	11		
		3.4 Adjust panel time	11
		3.5 Change panel mode	12
		3.6 Change sensor name	12
		3.7 Elderly care alarm	13
		3.8 Two-ways talk	14
		3.9 Schedule arm panel	14
		3.10 Alarm tone duration	15
		3.11 Turn off time display	16
		3.12 Mains power lost alarm	16
		3.13 Alarm notification	16
		3.14 Low battery alarm	17
		3.15 SMS to users	17
		3.16 Weak GSM signal alarm	17
		3.17 Reset factory setting	18
		Appendix: SMS commands list	19
		Technical specification	22

Chapter 1: General system overview

• 1.1 Product description

Thank you for purchasing the SimPal-G212.

GSM Alarm System is a quality security system with a wide range of user friendly features. The system is controlled by a Wireless Alarm Panel, which gathers information from wireless sensors placed around and at the entry points of your home or office. If the Wireless Alarm Panel detects somebody moving or security exceptions, it will display digital zone number and the siren will sound.

A SIM card can be used in the Panel to send out the alarm message by SMS, or making emergency phone calls. The user calls the Panel to listen in live voice or communicate with the morning area.

Details of the functioning and advanced operation of this device are described in this instruction manual.

• **1.2 Package contents**

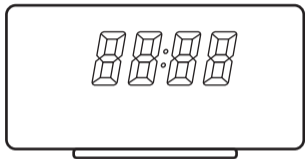

Alarm panel
1 pcs

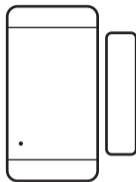

Door/Window sensors
1 pcs

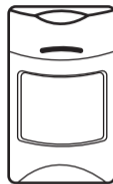

PIR detector
1 pcs

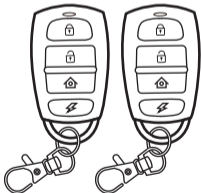

Keychain remote controls
2 pcs

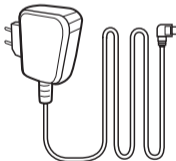

AC power adapter (5V)
1 pcs

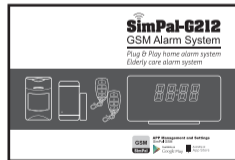

User manual
1 pcs

• 1.3 Alarm panel instruction

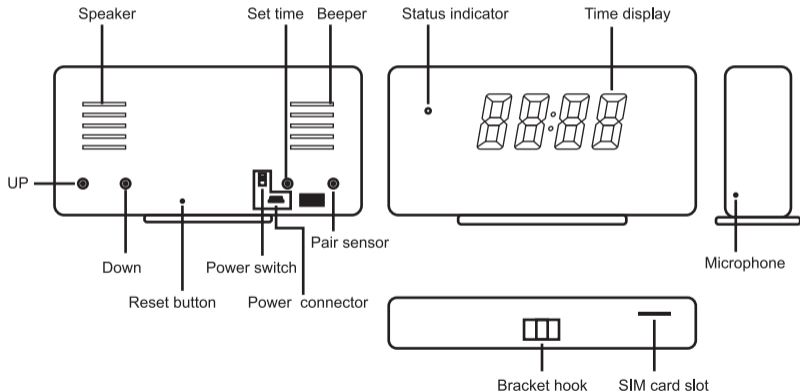

• **1.4 Remote control instruction**

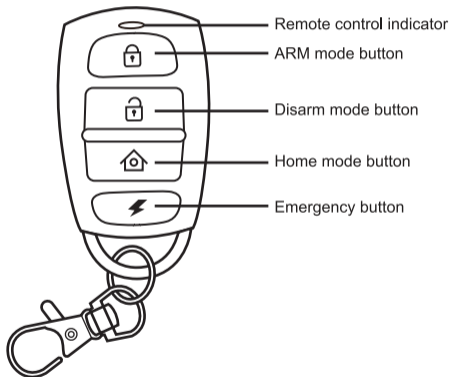

Chapter 2: Start to use

• 2.1 Installation

- The alarm panel work with Micro SIM card (middle size SIM), make sure the SIM card have Caller ID functions activated and the PIN code deactivated.
- Put the SIM card metal contact downward, cut-corner at the right, and push SIM card inside until fully locked. When SIM card installed, the whole SIM card full inside the housing.
- Connected the power adaptor onto alarm panel and plug the adaptor into AC power socket.
- Power on/off: Turn the power switch to “On” position, panel will power on within 20 seconds after system initialization. Turn the power switch to “OFF” position and it will power off.
- Install the bracket onto panel hook, put the alarm panel desktop. Then it's ready to work.

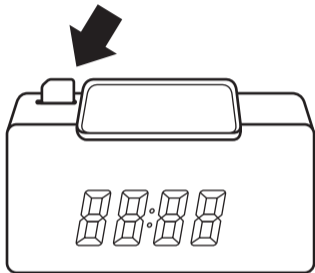

• 2.2 LED indicator and beeper

LED indicator	Status
Breath RED	Disarm Mode (without SIM card)
Slow flash RED	✓ Search GSM network ✓ Home mode (without SIM card)
Constant RED	Arm mode (without SIM card)
Breath Green	Disarm mode
Slow flash Green	Home mode
Constant Green	Arm mode
Fast flash Green	Process SMS command
Fast flash RED	Panel alarm

Beeper	Status
One short beep	✓ Press setting button ✓ Pair sensor
One long beep	✓ Pair sensor success ✓ Reset factory setting
Two beep	Sensor already paired, need to delete before pair again.
Three beep	Zone number already paired, need to pair in other zone

• 2.3 Zone type and alarm tone

Alarm panel max support 5pcs remote control and 18pcs wireless sensor. There are four types wireless sensor: Alarm, Home, Emergency and Doorbell. Press “Pair” button at the back of alarm panel, it will beep and display zone type + zone number. Corresponding zone type and zone number as following:

Zone type	Alarm	Home	Emergency	Doorbell	Elderly Care
Zone number	1-5	6-10	11-15	16-18	19-20
Display	A	B	C	D	E

When sensor trigger, corresponding alarm tone as following:

Alarm panel Sensor type	Arm mode	Disarm mode	Home mode
Alarm sensor (Display “A”)	Alarm tone & SMS	---	---
Home sensor (Display “b”)	Alarm tone & SMS	---	Doorbell tone
Emergency sensor (Display “C”)	Alarm tone & SMS	Alarm tone & SMS	Alarm tone & SMS
Doorbell sensor (Display “d”)	Doorbell tone	Doorbell tone	Doorbell tone
Elderly Care (Display “E”)	---	---	---

• 2.4 Pair remote control and wireless sensor

Press “Pair” button at back of panel, it will beep and display zone type and zone number. When this zone number do not pair, it will display flash, means can be pair sensor on this zone. When zone already paired, it will display without flash, can not pair on this zone. Press “Up”, “Down” button to select zone number to pair.

2.4.1 Pair remote control

Press “pair” button and select Zone number, press any button of remote control, it will long beep and auto exist pair mode.

2.4.2 Pair wireless sensor

Press “Pair” button and select zone number, trigger wireless sensor. It will long beep when paired success and auto exist pair mode. If panel beep twice, it means this sensor already paired before, need to delete this sensor before pair again.

2.4.3 Delete remote control and wireless sensor

- Delete remote control

Keep press “Pair” button for 5 seconds, it will long beep and deleted all paired remote control.

- Delete wireless sensor:

Press “Pair” button, use “Up” “Down” button to select the paired sensor zone, press the “Setting” button, then it will deleted this zone sensor and zone number display flash.

Chapter 3: SMS alarm and Settings

• 3.1 Register Master and User number

Max allow register 5 numbers for one alarm panel, one Master and four users. Only registered number can be receive alarm SMS from panel; Master have full authorization to configure panel, other four users only have basic function.

Master and User send SMS to alarm panel SIM card; it will process SMS content according different command code. Command code format is #number#, the symbol # cannot be ignored. No allow add space within the command.

• 3.2 Register Master number

When SIM card installed, the LED will flash in green color. Master sends following SMS to

Register Master number: #00# (1)

• Note: If LED indicator in RED color, means do not find SIM card or can not register GSM network, suggest to check the SIM card in mobile phone. Need to disable SIM card PIN code.

• 3.3 Register User number

Max 4 user number can be add for one panel, User number only can be register by Master number.

Master sendS following SMS to:

Add User number: #06#User-Number# (2)

Check register number list: #06# (3)

When User number full, need to deleted old user before register new one. Master sends following SMS to:

Delete one User: #15#User-Number# (4)

Delete all Users: #15# (5)

• 3.4 Adjust panel time

Panel will auto update time from any incoming SMS. If incoming SMS time is wrong, it can be adjust time manually. Master send following SMS to set:

Update time from SMS – OFF: #29#0# (6)

Update time from SMS – ON (default): #29#1# (7)

After send SMS to disable update time from SMS, press “Setting” button, hour zone will flash, press “Up” “Down” button to set correct hour; press “Setting” again, it will save hour setting and minute zone flash, press “up” “Down” button to set correct minutes, press “setting” button to save the settings.

• 3.5 Change panel mode

There are four working mode for alarm panel, it will process sensor alarm according its settings. Two methods to switch panel working mode:

Method 1: By press remote control button

- Arm mode: Press remote control first button , it will beep and make panel work in arm mode. There are 30 seconds delay arm, LED will flash two slow one fast, after 30 seconds, LED will constant light in green. Means panel in arm mode.
- Disarm mode: Press remote control second button , it will beep twice and LED flash breath in green.
- Home mode: Press remote control third button , it will long beep and LED flash slowly in green.

Method 2: By SMS command.

Master or User sends following SMS to set:

Arm mode: #01# (8)

Disarm mode: #02# (9)

Home mode: #03# (10)

Check panel status: #07# (11)

• 3.6 Change sensor name

It can change sensor name for zone number 1-15, when sensor alarm, it will included name in SMS to separate different sensor.

Master sends following SMS to set:

Sensor rename: #04#zone-number#name# (12)

For example: send SMS #04#1#Door#, it will name Zone 1 “Door”, when zone 1 sensor alarm, it will send SMS “Zone 1: Door alarm.”.

Noted: sensor name only can be English characters or digital number, max allow 15 characters.

Master sends following SMS to:

Check sensor list: #04# (13)

Delete all remote control: #09#1# (14)

Delete all wireless sensor: #09#2# (15)

• 3.7 Elderly care alarm

When sensor paired on Zone 19-20, it will work as elderly care sensor. When sensor do not trigger more than 24 hours, panel will send SMS alarm. It can send SMS to change the time duration.

Set elderly care duration: #31#hour# (16)

Duration value range is 1-24, means 1-24 hours.

Elderly care alarm – ON (default): #32#1# (17)

Elderly care alarm – OFF: #32#0# (18)

• 3.8 Two-ways talk

Master or User can call the pane to start two-ways voice talk, also can send SMS to start listen in, listen in mode only can listen local voice, panel speaker was turn off. Master or User sends following SMS to:

Start listen in calling: #18# (19)

Master can change the settings to disable calling function, or calling to arm/disarm panel.

Disable calling function: #21#0# (20)

Calling to start voice calling (default): #21#1# (21)

Calling to arm/disarm panel: #21#2# (22)

• 3.9 Schedule arm panel

Panel can be set to auto arm/disarm according setting schedule, User can temporarily manual change arm/disarm status, panel will check arm/disarm status when reach setting time point.

Master sends following SMS to:

Schedule arm panel – ON: #20#1# (23)

Set schedule arm period: #20#day#start-time#end-time# (24)

Schedule arm panel – OFF (default): #20#0# (25)

For day and time parameters, the corresponding parameters as following:

Value	Corresponding day
0	Everyday
1	Monday
2	Tuesday
3	Wednesday
4	Thursday

Value	Corresponding day
5	Friday
6	Saturday
7	Sunday
8	Monday to Friday
9	Weekend

- **StartTime** and **EndTime**: Be consists of 4 digits (hh:mm) and works on a 24 hour clock. If **StartTime** bigger than **EndTime**, it will operate until next day EndTime.
- Panel will arm at the **StartTime** and disarm at the **EndTime**.
- For example: #20#0#1800#0800# , 0 means everyday, 1800 means time 18:00 0800 means time 08:00. Panel will arm at 18:00 and disarm at next day 08:00.

• 3.10 Alarm tone duration

When sensor trigger, panel will sound alarm tone to scare intruder. Master can turn off the alarm tone or change alarm tone duration.

Master sends following SMS to:

Set alarm tone duration: #16#duration# (26)

Duration value range is 0-600, means 0-600 seconds. It will turn off alarm tone when set duration 0.

- Note: duration do not included panel sending SMS time. Depend on Master and user quantity, it may ring 3-10 seconds longer than setting value.

• 3.11 Turn off time display

Panel can be set to turn off time display and turn off LED indicator. Master sends following SMS to set:

Time display and LED indicator – OFF: #28#0# (27)

Time display and LED indicator – ON (default): #28#1# (28)

• 3.12 Mains power lost alarm

Panel default sends SMS to Master and Users when mains power lost or restore, it can be set to turn off this function.

Master sends following SMS to set:

SMS when power lost – ON (default): #05#1# (29)

SMS when power lost – OFF: #05#0# (30)

• 3.13 Alarm notification

Panel default send SMS to Master and Users when sensor alarm, it can set make calling when sensor alarm. Master can change the settings.

Master sends following SMS to set:

SMS at alarm – ON (default): #11#1# (31)

SMS at alarm – OFF: #11#0# (32)

Voice call at alarm – ON: #10#1# (33)

Voice call at alarm – OFF (default): #10#0# (34)

• 3.14 Low battery alarm

Panel default send SMS when battery level lower than 30%, Master can set to turn off this function.

Master sends following SMS to set:

Low battery alarm – ON (default): #30#1# (35)

Low battery alarm – OFF: #30#0# (36)

• 3.15 SMS to users

Panel default sends SMS to both Master and Users when sensor alarm or mains power change.

Master sends following SMS to set:

SMS to users –ON (default): #12#1# (37)

SMS to users – OFF: #12#0# (38)

• 3.16 Weak GSM signal alarm

When panel work in weak GSM signal, it may lost GSM network. The GSM signal range is 0-31, best signal is 31. When signal lower than 10, it may lost connection from GSM network and can not send SMS or make calling. It can set panel send SMS when GSM signal lower than 10.

Weak GSM signal alarm – ON: #27#1# (39)

Weak GSM signal alarm – OFF (default): #27#0# (40)

• 3.17 Reset factory setting

Panel can be reset factory to clean all registered numbers and paired sensors.

Method 1: Master sends following SMS to:

Reset panel factory setting: #08#1234# (41)

Method 2: Use small sharp needle or metal pin press on the small reset hole, keep press for 1 second, panel will long beep and reset factory settings.

Appendix: SMS commands list

Function	Command
(1) Register Master number	#00#
(2) Add User number	#06#User-number#
(3) Check number list	#06#
(4) Delete one user	#15#User-number#
(5) Delete all users	#15#
(6) Update time from SMS - OFF	#29#0#
(7) Update time from SMS – ON (default)	#29#1#
(8) Set arm mode	#01#
(9) Set disarm mode	#02#
(10) Set home mode	#03#
(11) Check status	#07#
(12) Sensor rename	#04#zone#name#
(13) Check sensor list	#04#
(14) Delete all remote control	#09#1#
(15) Delete all sensor	#09#2#
(16) Set elderly care duration	#31#hour#
(17) Elderly care alarm – ON (default)	#32#1#

Function	Command
(18) Elderly care alarm – OFF	#32#0#
(19) Start listen in calling	#18#
(20) Disable calling function	#21#0#
(21) Two-ways calling – ON (default)	#21#1#
(22) Calling to arm/disarm	#21#2#
(23) Schedule arm panel - ON	#20#1#
(24) Set schedule parameter	#20#day#starttime#endtime#
(25) Schedule arm panel – OFF (default)	#20#0#
(26) Set alarm tone duration	#16#duration#
(27) Time display and LED - OFF	#28#0#
(28) Time display and LED – ON (default)	#28#1#
(29) SMS when power lost – ON (default)	#05#1#
(30) SMS when power lost – OFF	#05#0#
(31) SMS at alarm – ON (default)	#11#1#
(32) SMS at alarm - OFF	#11#0#
(33) Calling at alarm – ON	#10#1#
(34) Calling at alarm – OFF (default)	#10#0#

Function	Command
(35) Low battery alarm – ON (default)	#30#1#
(36) Low battery alarm – OFF	#30#0#
(37) SMS to user – ON (default)	#12#1#
(38) SMS to user - OFF	#12#0#
(39) Weak GSM signal alarm - ON	#27#1#
(40) Weak GSM signal alarm – OFF (default)	#27#0#
(41) Reset factory setting	#08#1234#

Technical specification

Power adaptor:	mini USB / 5V 1000mA
GSM frequency:	850/900/1800/1900Mhz
SIM card size:	Micro SIM (middle size)
Built-in battery:	1500mAh
Built-in siren:	100dB
Radio frequency:	433.92Mhz FSK
Radio distance:	up to 40 meters
Sensor zone number:	total 20pcs
Housing material:	ABS plastic
Dimension:	137 x 75 x 32 mm (L x H x W)
Operation Condition:	Temperature 0°C ~ +55°C
Relative Humidity	< 80% (Non-condensing)

